

PSUs

LINEAR POWER SUPPLIES

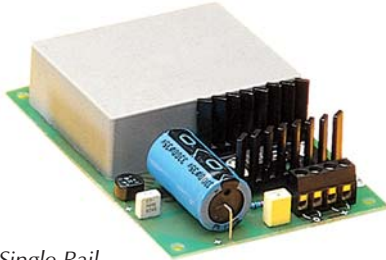

Lascar's linear power supplies all feature screw terminals & an encapsulated mains transformer. A wide range of input/output voltages is available in single, dual & triple rail options.



Single Rail

Stock No. **PSU 20105**

- Low profile
- Encapsulated mains transformer
- 120V a.c. or 240V a.c. input
- 1000mA @ 5V d.c.
- Screw terminal connection

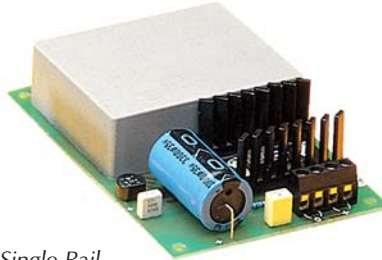

Single Rail

Stock No. **PSU 20112**

- Low profile
- Encapsulated mains transformer
- 120V a.c. or 240V a.c. input
- 500mA @ 12V d.c.
- Screw terminal connection

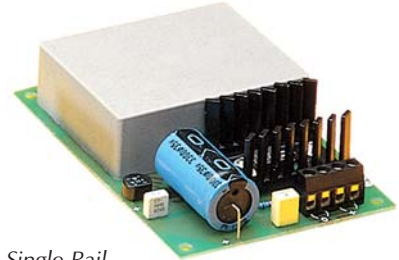

Single Rail

Stock No. **PSU 20115**

- Low profile
- Encapsulated mains transformer
- 120V a.c. or 240V a.c. input
- 300mA @ 15V d.c.
- Screw terminal connection



Dual Rail

Stock No. **PSU 203**

- Low profile
- Encapsulated mains transformer
- Positive & negative adjustable rails
- 20-turn trimmers for accuracy
- 120V a.c. or 240V a.c. input
- 150mA @ 5V to 15V d.c.
- 150mA @ -5V to -15V d.c.
- Screw terminal connection

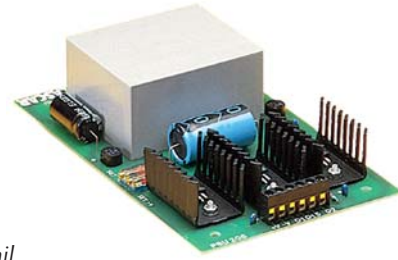

Triple Rail

Stock No. **PSU 206**

- Encapsulated mains transformer
- 120V a.c. or 240V a.c. input
- Fixed 5V output
- Separate fully adj. split rail outputs
- 1000mA @ 5V d.c.
- 250mA @ 5V to 15V d.c.
- 250mA @ -5V to -15V d.c.
- Screw terminal connection



Single Rail

Stock No. **PSU 30205**

- Compact design
- Encapsulated mains transformer
- 240V a.c. input
- 100mA @ 5V d.c.
- Screw terminal connection



Dual Rail

Stock No. **PSU 303**

- Compact design
- Encapsulated mains transformer
- 120V a.c. or 240V a.c. input
- Positive & negative fixed rails
- 200mA @ 5V d.c.
- 50mA @ -5V d.c.
- Screw terminal connection

FOR A FULL PRODUCT DATA SHEET, PRICING AND ON-LINE STORE VISIT:

www.lascarelectronics.com



Mechanical Specification

All dimensions in mm (*inches*)

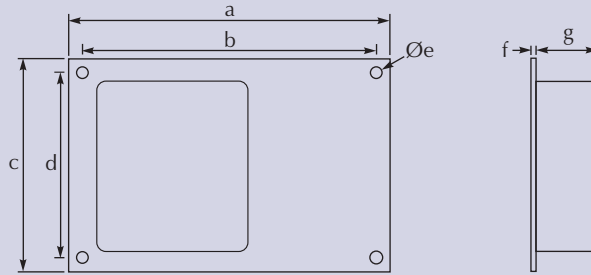

	PSU 201XX	PSU 203	PSU 206	PSU 30205	PSU 303
a.	115.0 (4.53)	105.0 (4.13)	160.0 (6.30)	50.0 (1.97)	78.0 (3.07)
b.	105.0 (4.13)	95.0 (3.74)	140.0 (5.51)	41.0 (1.61)	68.0 (2.68)
c.	76.0 (2.99)	76.0 (2.99)	100.0 (3.94)	41.0 (1.61)	42.0 (1.65)
d.	66.0 (2.60)	66.0 (2.60)	75.0 (2.95)	32.0 (1.26)	32.0 (1.26)
e.	4.0 (0.16)	4.0 (0.16)	4.0 (0.16)	3.2 (0.13)	4.0 (0.16)
f.	1.6 (0.06)	1.6 (0.06)	1.6 (0.06)	1.6 (0.06)	1.6 (0.06)
g.	22.0 (0.87)	22.0 (0.87)	36.0 (1.42)	28.0 (1.10)	28.0 (1.10)

XX = 05, 12 or 15

Dimensions	PSU 20105	PSU 20112	PSU 20115	PSU 203	PSU 206	PSU 30205	PSU 303
External (L x W x H)	115 x 76 x 23.6mm 4.53 x 2.99 x 0.93	115 x 76 x 23.6mm 4.53 x 2.99 x 0.93"	115 x 76 x 23.6mm 4.53 x 2.99 x 0.93"	105 x 76 x 23.6mm 4.13 x 2.99 x 0.93"	160 x 100 x 37.6mm 6.30 x 3.94 x 1.48"	50 x 41 x 29.6mm 1.97 x 1.61 x 1.17"	78 x 42 x 29.6mm 3.07 x 1.65 x 1.17"

Specification	PSU 20105	PSU 20112	PSU 20115	PSU 203	PSU 206	PSU 30205	PSU 303
Load regulation (max.)	1%	1%	1%	1%	1%	1%	1%
Line regulation (max.)	1%	1%	1%	1%	1%	1%	1%
Ripple (max.)	5mV	5mV	5mV	5mV	10mV	0.5mV	0.5mV
Operating temperature	0°C to 70°C*	0°C to 70°C*	0°C to 70°C*	0°C to 70°C*	0°C to 70°C*	0°C to 70°C	0°C to 50°C
Output	Fixed Positive	1000mA @ 5V d.c.	500mA @ 12V d.c.	300mA @ 15V d.c.	-	1000mA @ 5V d.c.	200mA @ 5V d.c.
	Fixed Negative	-	-	-	-	-	50mA @ -5V d.c.
	Adjustable Positive	-	-	-	150mA @ 5 to 15V d.c.	250mA @ 5 to 15V d.c.	-
	Adjustable Negative	-	-	-	150mA @ -5 to -15V d.c.	250mA @ -5 to -15V d.c.	-
Input (50-60Hz)	120 or 240V a.c.	120 or 240V a.c.	120 or 240V a.c.	120 or 240V a.c.	120 or 240V a.c.	240V a.c.	120 or 240V a.c.

* Subject to de-rating above 25°C.

Mounting Method

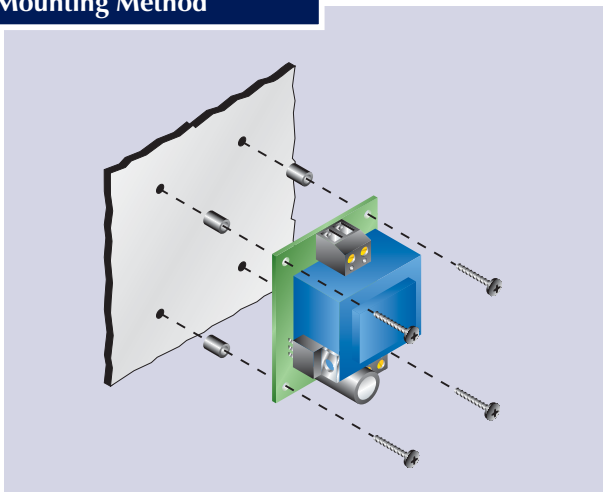

Connection

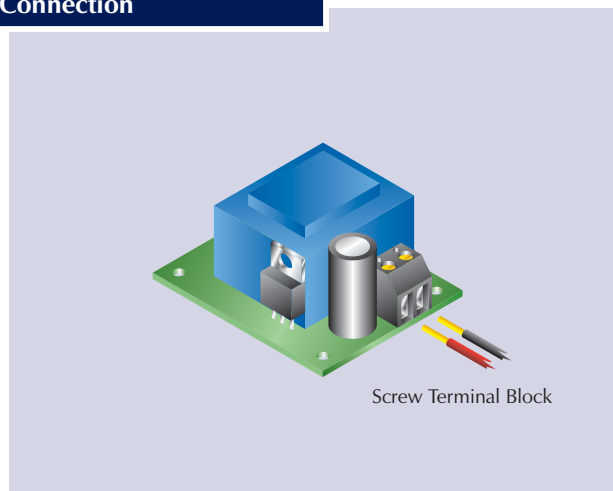

Please note that all specifications are correct at time of print. The Company reserves the right to change any specification, typographical, clerical or other error or omission without any liability on the part of the company.

Lascar Electronics Limited

Module House, Whiteparish, Salisbury,
Wiltshire SP5 2SJ UK

Tel: +44 (0)1794 884567 Fax: +44 (0)1794 884616
E-mail: sales@lascar.co.uk

Lascar Electronics, Inc.

3750 West 26th Street,
Erie, PA 16506

Tel: +1 (814) 835 0621 Fax: +1 (814) 838 8141
E-mail: us-sales@lascarelectronics.com

Lascar Electronics (HK) Limited

Flat C, 5/FL., Lucky Fly, Bldg., 63-65 Hung To Road,
Kwun Tong, Kowloon, Hong Kong

Tel: +852 2797 3219 Fax: +852 2343 6187
E-mail: b4lascar@samsongroup.com.hk

